



ULP-CM3255  
Ceiling TV Mount

**1. Product Features:**

ULP-CM3255 Product weight: 5kg ; TV size support: 32"- 55"; Distance to the wall: 810-1030mm ; Maximum load: 30kg; For Vesa Standard 400 x 400mm

**Important:** The Supplier and /or Manufacturer will not be held liable for any personal injury or product damage due to mishandling, incorrect mounting, incorrect assembly or incorrect use of this product.

**Note:** The supplied wall mounting hardware is not for use on steel stud walls or cold cinder block walls. If you are uncertain what material your wall is constructed of or have any questions regarding the proper installation of this wall mount, contact a qualified contractor. If the hardware required is not included, please contact your local hardware store.

**Caution:** This LCD/Plasma wall mount is intended for use on a LCD/LED/Plasma television that does not exceed the maximum designated weight capacity. Using this mount with products heavier than the maximum weight indicated may result in instability causing possible injury.













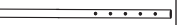

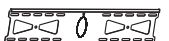









**Disclaimer  
Without Prejudice of Rights**

In order to indemnify the Supplier and/ or Manufacturer please note that once this product is purchased the Client/ Purchaser agrees to the following:

Should the product .in an unlikely event, fail to operate according to its purpose,Interfoto CC hereby declare to repair or replace any part of the mechanism which is found to be defective after a full investigation as to the cause. In the case of defects occurring due to an external third party and / or the Client / Purchaser installing it incorrectly, misuse or overloading and/ or using it for any other purpose other than that for which it was intended, neglect or damage, external parties repairing or modifying the mechanism in any way and or its spare parts, if the enclosed operating instructions were not followed, the Supplier and /or Manufacturer shall not be held liable for any damage caused to the product placed on the mechanism or wall which the mechanism is attached to or any other property and personal injury.

Note: Proof of purchase to be produced for any claim. This product carries a ten year warranty for manufacture faults/failures.

Parts list

No.	Description	Specifications Model	Qty.
1		Join arm-1	x1
2		Wall plate	x1
3		Join arm-2	x1
4		plastic cover	x1
5		Arm	x2
6		plate	x1
7		Bar	x1
8		joint 1	x1
9		joint 2	x1
A		M8 Plastic screw	x4
B		M5.3x40mm Wallboard screw	x4
C		M4x5mm Wood screw	x1
D		M8x45mm Cross round screw	x1
E		M8 Screw nut	x1
F		Φ8 Iron washer	x1
G		M6x14 Carriage screw	x4
H		Adjustment screw	x1
I		M8x16mm Cross round screw	x4
J		M6x20mm Cross round screw	x4
K		washer	x4
L		Φ6plastic spacer	x4
M		M6x65mm Cross round screw	x1
N		Φ6x16 washer	x14
O		M6 Screw nut	x5
P		Spirit Level	x1

**IMPORTANT SAFETY INSTRUCTIONS**

Check your TV user manual instructions to see if there are any special requirements for mounting your TV.

If you do not understand these instructions or have doubts about the safety of the installation, assembly or use of this product, contact:

INTERFOTO CC  
Website: www.ultralink.co.za  
Email: service@interfoto.co.za  
Address: 362 Roan Crescent,  
Corporate Park North, Midrand  
Tel: +2786 006 1046

# Instructions for installation

1

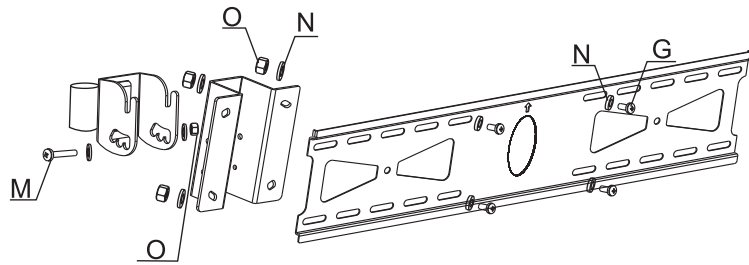

Assemble the illustrated parts.

3

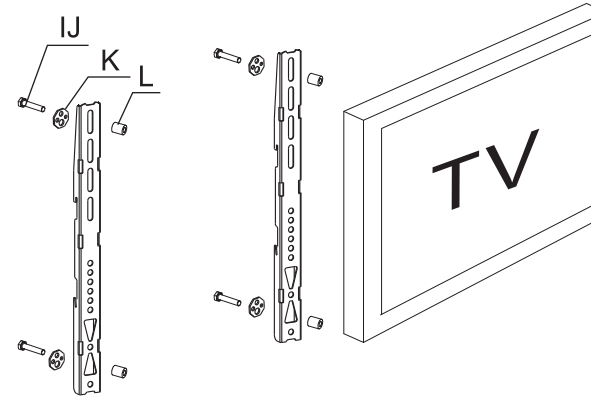

Use Long bolt (I or J), washer (K) and spacer (L) to mount TV set to the aluminum siding.

2

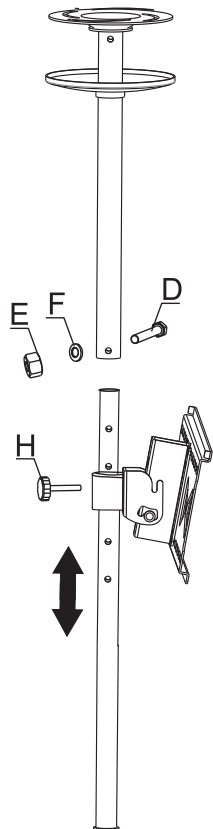

Put the wall plate on joint arm -1 and then do the same with the plastic cover.

Use Cross round screw (D) , washer (F) and Screw nut (E) to join Join arm -1 and Join arm -2.

4

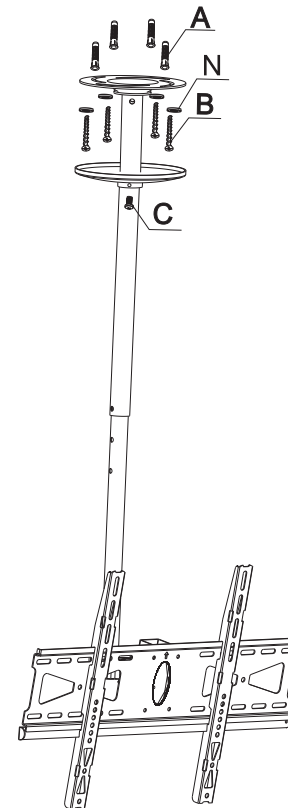

Use the spirit level to ensure the wall plate is level, then Pre-drill 4 holes with a 10mm bit (50mm deep.)

Insert plastic screws (A) into the holes, then use wallboard screws (B) with washer (N) to mount the wall to studs.