

# **ULTRA-LINK**



**PORTABLE BLUETOOTH RADIO**

**MEGA-BASS PARTY SPEAKER**

PREMIUM SERIES

**USER MANUAL**

UL-BTPS60

## **SAFETY INFORMATION**

Please read this user manual carefully before using the product.

1. There are high voltage zones inside this unit that can cause injuries. Please do not disassemble unit. In case of technical failure, please contact the authorized service center.
2. Never place the unit in the rain or in moist zones to avoid a fire or an electric shock.
3. This device uses a laser system. To prevent direct exposure to the laser beam, please do not disassemble the unit or stare at the laser beam.
4. If technical maintenance is required, please contact the authorized service center.
5. If the supply cord is damaged in any way, please have it replaced by the manufacturer, supplier or a qualified electrician.

### **Caution**

1. Do not place the unit on an unstable surface as it may fall and break or cause damage to people or pets.
2. Disconnect the unit from the mains before cleaning it. Do not use cleaning liquids or sprays.
3. Use only a soft, damp cloth.
4. To avoid possible damage to the equipment, please unplug it during storms or when it will not be used for a long time.
5. Do not insert any object into the unit through the ventilation openings as this could cause a short circuit and start a fire. Do not pour liquid on the speaker.

### **What's in the box?**

- Speaker unit
- User Manual
- Remote Control
- Power cable

## PARTY SPEAKER TOP CONTROLLING PANEL

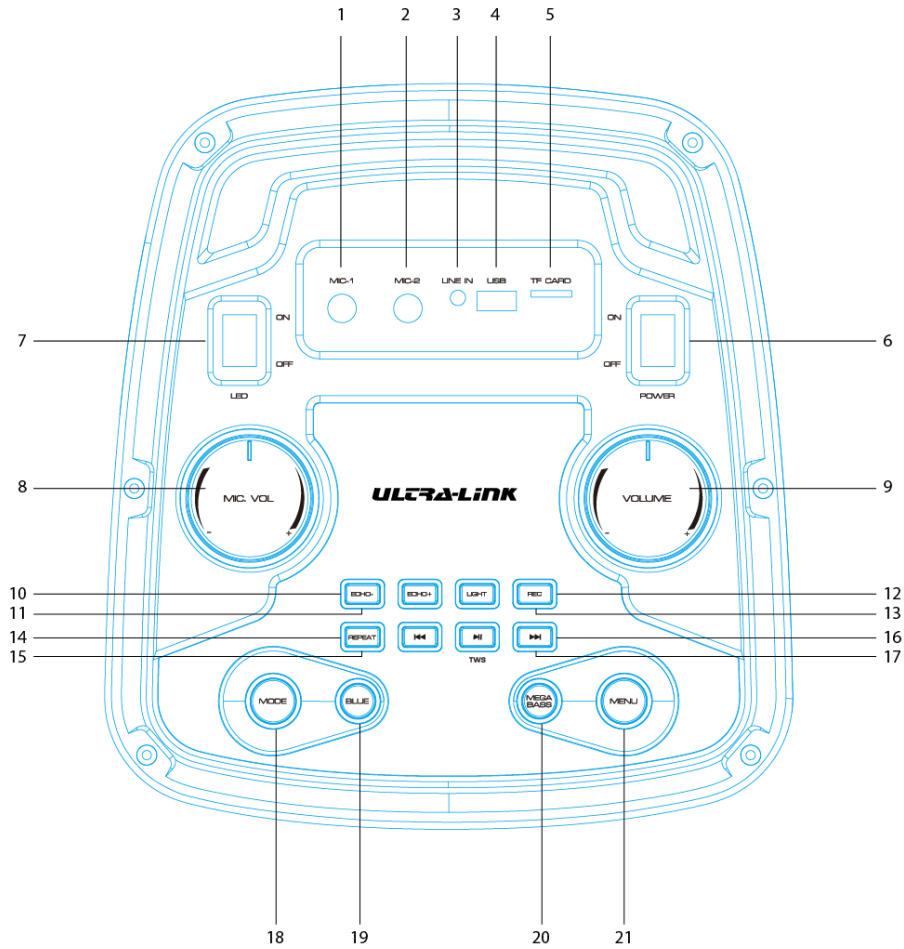

1.	Microphone Input	12.	Record function
2.	Microphone Input	13.	Change Light Mode
3.	Line in	14.	Repeat Function
4.	USB Input	15.	Previous Song
5.	TF Card Input	16.	Next Song
6.	Power ON/OFF	17.	Pause & Play, Long Press TWS Function
7.	LED Light Switch	18.	Mode; Line in, USB Mode, TF Card, FM Radio, Wireless BT
8.	MIC Volume	19.	Wireless BT Function
9.	Main Volume	20.	EQ: Press to switch to different EQ settings
10.	Echo-	21.	Mega Bass
11.	Echo+		

## REMOTE CONTROL

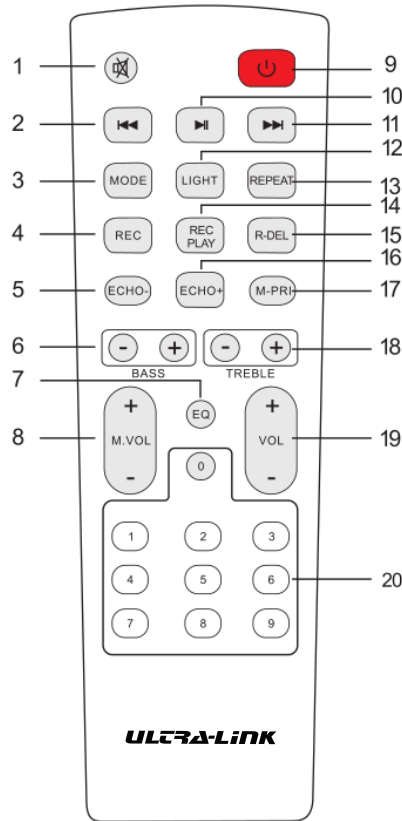



1.	Mute: Mutes the sound in any Mode	11.	Next Song
2.	Previous Song	12.	Changes the light mode: press to cycle through the various modes
3.	Mode: Press Shortly to skip to Wireless BT/Line In/ USB/ TF Mode	13.	Repeat function
4.	Record function: In USB/TF Mode, press "REC" button to record	14.	Play the recorded file
5.	Echo-	15.	Delete the recorded file
6.	Bass+/-	16.	Echo+
7.	EQ function	17.	Microphone Priority
8.	Microphone Volume +/-	18.	Treble+/-
9.	Stand by	19.	Main Volume
10.	Pause/Play	20.	Number Buttons In USB/TF mode enter directly the number of the desired songs

# PAIRING PROCEDURE

## BLUETOOTH MODE:



Press MODE or Blue button on the unit or the remote control until BT is displayed.

1. Place your mobile phone or Bluetooth device within a 10m proximity.
2. Activate the BT search function on your cell phone to search for the BT device. Please refer to the user manual for details.
3. Select **UL-BTPS60** in the list of found devices.
4. Press the PLAY/PAUSE button  to play or pause the music. Press the "" or "" button to select the previous or next track.

## LINE IN MODE:

Press the MODE button on the unit or the remote control until LINE is selected. Navigate the music connected to the LINE input on your mobile phone or Bluetooth device.

## USB MODE:

1. Press MODE to select "USB" and insert the USB device. The unit will automatically read and play the music on the USB device.
2. Press "" button shortly to pause or play.
3. Shortly press "" button to select previous song.
4. Shortly press "" button to select the next song.

## TWS MODE:

1. The two speakers can be connected together in TWS mode.
2. Place the two TWS speakers near each other (the distance should not be more than 10 meters).
3. Switch on the two speakers, both speakers selected to BLUETOOTH mode, press and hold for approximately 5 seconds. Select the TWS button on one speaker as the master speaker, thereafter the TWS connection will be activated.
4. In TWS mode, press and hold the TWS button for approximately 5 seconds on either speaker or switch off the speaker to exit the TWS mode.

# ***ULTRA-LINK***

If you are experiencing any problems with the setup or the product itself, please contact:

INTERFOTO CC

Website: [www.ultralink.co.za](http://www.ultralink.co.za)

Email: [support@ultralink.co.za](mailto:support@ultralink.co.za)

Address: 20 Roan Crescent,  
Corporate Park North, Midrand

Tel: +2786 006 1046